

# MR-GI3M2P-TR2

## monitoring relays



- Multifunctions monitoring relays (AC current monitoring in 3-phase network, with adjustable thresholds)
- Fault latch mode • Timing adjustment of start-up suppression and tripping delay ❶ • Supply via TR2 supply transformer ❷
- Output: 2 CO (2 changeover contacts)
- Industrial cover, width 22,5 mm
- Direct mounting on 35 mm rail mount acc. to PN-EN 60715
- Recognitions, certifications, directives: **CE**

### Output circuit - contact data

Number and type of contacts	2 CO	
Rated voltage	250 V AC	
Max. breaking capacity	AC1	750 VA (3 A / 250 V AC) ❸ 1 250 VA (5 A / 250 V AC) ❹
Max. operating frequency	3 600 cycles/hour	
• at resistive load 100 VA	360 cycles/hour	
• at resistive load 1 000 VA		
<b>Input circuit</b>		
Supply voltage	AC	12 ... 400 V ❷ terminals A1-A2
Must release voltage	AC: $\geq 0,3 U_n$	
Operating range of supply voltage	as per the specification of TR2 supply transformer ❷	
Rated power consumption	AC	2,0 VA / 1,5 W
Range of supply frequency	AC	as per the specification of TR2 supply transformer ❷
Duty cycle	100%	
<b>Measuring circuit</b>	<ul style="list-style-type: none"> <li>• measuring variable</li> <li>• measuring inputs</li> <li>• overload capacity</li> <li>• input resistance</li> <li>• switching threshold</li> </ul>	AC sinus, 48...63 Hz (frequency response: -10...+5%) AC: 5 A terminals K-I1 AC: 5 A terminals K-I2 AC: 5 A terminals K-I3 6 A AC 10 m $\Omega$ MIN: 0,05...0,95 I <sub>n</sub> MAX: 0,1...1,0 I <sub>n</sub>
<b>Insulation according to PN-EN 60664-1</b>		
Rated surge voltage	4 000 V 1,2 / 50 $\mu$ s	
Overvoltage category	III	
Insulation pollution degree	3	
<b>General data</b>		
Electrical life	• resistive AC1	> 2 x 10 <sup>5</sup> 1 000 VA
Mechanical life (cycles)	> 2 x 10 <sup>7</sup>	
Dimensions (L x W x H)	90 x 22,5 x 108 mm	
Weight	100 g	
Ambient temperature	<ul style="list-style-type: none"> <li>• storage</li> <li>• operating</li> </ul>	-25...+70 °C -25...+55 °C
Cover protection category	IP 20 PN-EN 60529	
Relative humidity	15...85%	
Shock resistance	15 g 11 ms	
Vibration resistance	0,35 mm DA 10...55 Hz	
<b>Measuring circuit data</b>		
Functions	OVER, OVER+LATCH, UNDER, UNDER+LATCH, WIN, WIN+LATCH fault latch mode	
Range of delay timing adjustment	start-up suppression: 0...10 s tripping delay: 0,1...10 s ❶	
Base accuracy	$\pm$ 5% (calculated from the final range values)	
Setting accuracy	$\pm$ 5% (calculated from the final range values)	
Repeatability	$\pm$ 2%	
Voltage influence	$\pm$ 0,5%	
Temperature influence	$\pm$ 0,1% / °C	
Recovery time	500 ms	
LED indicator	green LED U ON - indication of supply voltage U green LED U flashing - indication of start-up suppression time ❷ red LEDs MIN and MAX ON/OFF - indication of failure ❸ red LEDs MIN and MAX flashing - indication of tripping delay ❹ yellow LED R ON/OFF - output relay status	

❶ Separately adjustable (two adjusting knobs). ❷ Supply voltage depending on the TR2 transformer which shall be ordered as a separate product - see page 4. ❸ If the distance between the mounting relays is less than 5 mm. ❹ If the distance between the mounting relays is greater than 5 mm. ❺ Indication of relay status - according to the set threshold.

19.04.2016

# MR-GI3M2P-TR2 monitoring relays

## Functions

For all functions the LED's MIN and MAX are flashing alternating, when the minimum value for the measured current was chosen to be greater than the maximum value. If a failure already exists, when the device is activated, the output relay R remains in off-position and the LED for the corresponding threshold is illuminated.

**OVER, OVER+LATCH** - Overcurrent monitoring, overcurrent monitoring with fault latch.

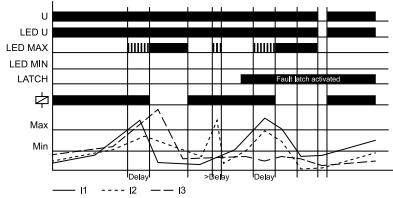

When the measured current of one of the phases exceeds the value adjusted at the MAX-regulator, the set interval of the tripping delay (Delay) begins (red LED MAX flashes). After the interval has expired (red LED MAX illuminated), the output relay R switches into off-position (yellow LED not illuminated). The output relay R again switches into on-position (yellow LED illuminated), when the measured current of all the phases falls below the value adjusted at the MIN-regulator (red LED MAX not illuminated). If the **fault latch** is activated (OVER+LATCH) and the measured current of one of the phases remains above the MAX-value longer than the set interval of the tripping delay, the output relay R remains in the off-position even if the measured current of all the phases falls below the value adjusted at the MIN-regulator. After resetting the failure (interrupting and re-applying the supply voltage), the output relay R switches into on-position and a new measuring cycle begins with the set interval of the start-up suppression (Start).

## Front panel description

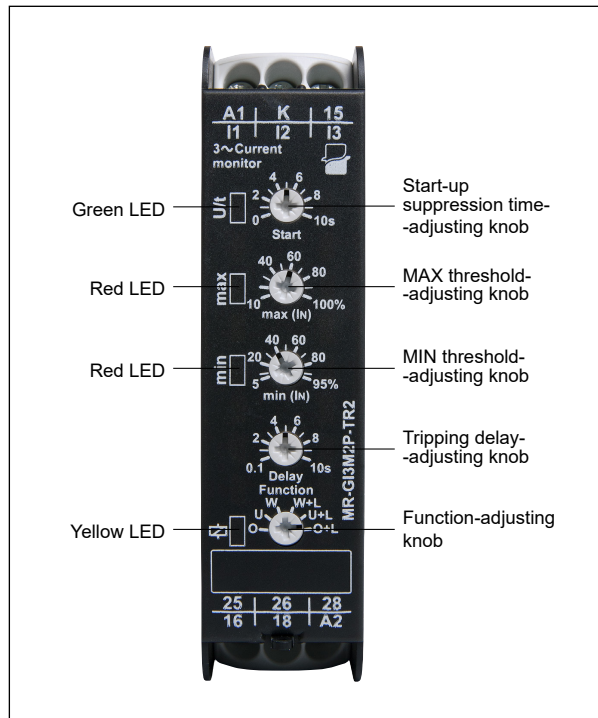

**U** - supply voltage; **R** - output state of the relay;  
**MIN, MAX** - relay status; **SEQ** - phase sequence

**UNDER, UNDER+LATCH** - Undercurrent monitoring, undercurrent monitoring with fault latch.

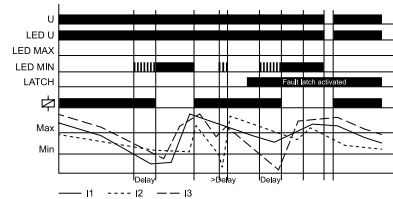

When the measured current of one of the phases falls below the value adjusted at the MIN-regulator, the set interval of the tripping delay (Delay) begins (red LED MIN flashes). After the interval has expired (red LED MIN illuminated), the output relay R switches into off-position (yellow LED not illuminated). The output relay R again switches into on-position (yellow LED illuminated), when the measured current of all the phases exceeds the value adjusted at the MAX-regulator.

If the **fault latch** is activated (UNDER+LATCH) and the measured current of one of the phases remains below the MIN-value longer than the set interval of the tripping delay, the output relay R remains in the off-position even if the measured current of all the phases exceeds the value adjusted at the MAX-regulator. After resetting the failure (interrupting and re-applying the supply voltage), the output relay R switches into on-position and a new measuring cycle begins with the set interval of the start-up suppression (Start).

**WIN, WIN+LATCH** - Current monitoring in windowfunction between MIN and MAX values, current monitoring in windowfunction between MIN and MAX values with fault latch.

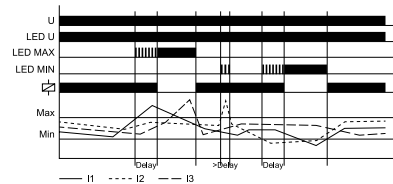

The output relay R switches into on-position (yellow LED illuminated) when the measured current of all the phases exceeds the value adjusted at the MIN-regulator. When the measured current of one of the phases exceeds the value adjusted at the MAX-regulator, the set interval of the tripping delay (Delay) begins (red LED MAX flashes). After the interval has expired (red LED MAX illuminated), the output relay R switches into off-position (yellow LED not illuminated). The output relay R again switches into on-position (yellow LED illuminated) when the measured current of all the phases falls below the value adjusted at the MAX-regulator (red LED MAX not illuminated). When the measured current of one of the phases falls below the value adjusted at the MIN-regulator, the set interval of the tripping delay (Delay) begins again (red LED MIN flashes). After the interval has expired (red LED MIN illuminated), the output relay R switches into off-position (yellow LED not illuminated).

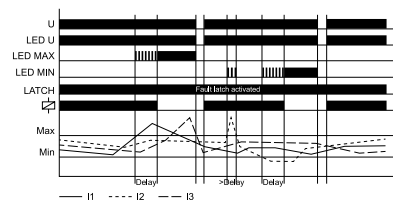

If the **fault latch** is activated (WIN+LATCH) and the measured current of one of the phases remains below the MIN-value longer than the set interval of the tripping delay, the output relay R remains in the off-position even if the measured current of all the phases exceeds the value adjusted at the MIN-regulator. If the measured current of one of the phases remains above the MAX-value longer than the set interval of the tripping delay, the output relay R remains in the off-position even if the measured current of all the phases falls below the value adjusted at the MAX-regulator. After resetting the failure (interrupting and re-applying the supply voltage), the output relay R switches into on-position and a new measuring cycle begins with the set interval of the start-up suppression (Start).

# MR-GI3M2P-TR2

## monitoring relays

### Dimensions

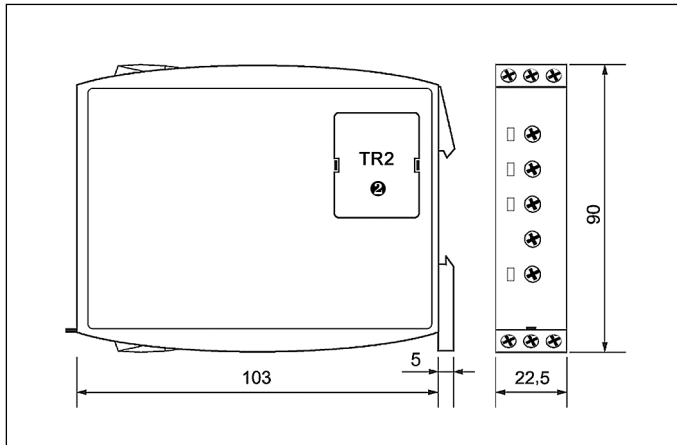

### Mounting

Relays **MR-GI3M2P-TR2** are designed for direct mounting on 35 mm rail mount acc. to PN-EN 60715. Operational position - any. **Terminals - cross section of the connection cables:** 1 x 0,5 ... 2,5 mm<sup>2</sup> with/without multicore cable end, 1 x 4 mm<sup>2</sup> without multicore cable end, 2 x 0,5 ... 1,5 mm<sup>2</sup> with/without multicore cable end, 2 x 2,5 mm<sup>2</sup> flexible without multicore cable end.

⊗ Supply voltage depending on the TR2 transformer which shall be ordered as a separate product - see page 4.

### Connection diagrams

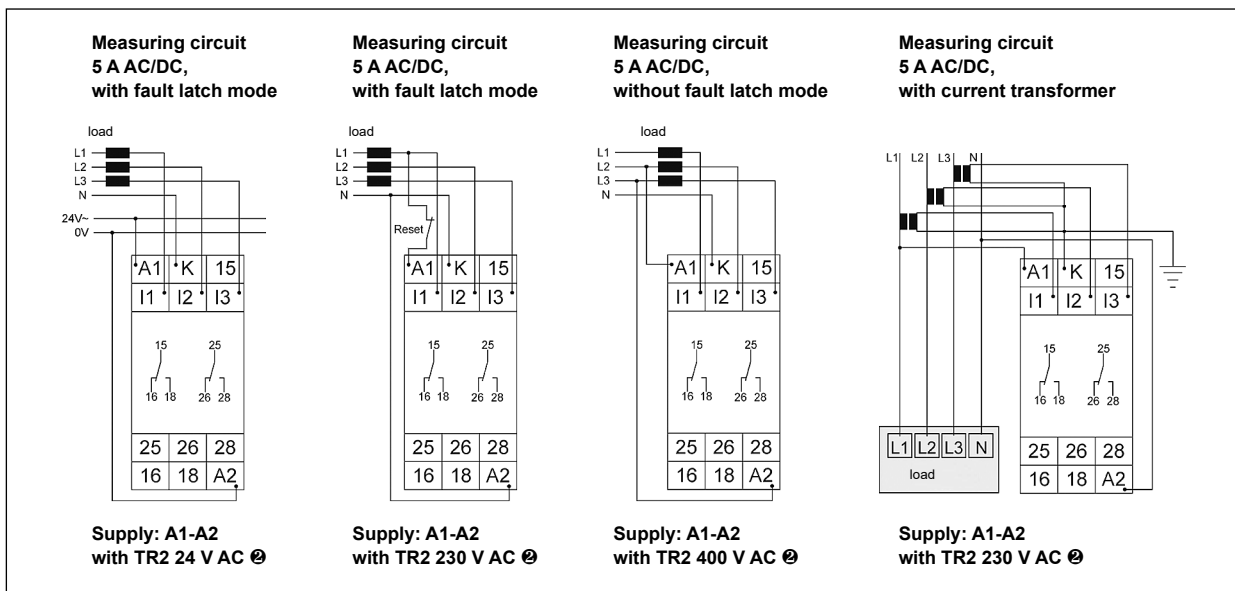

### Ordering codes

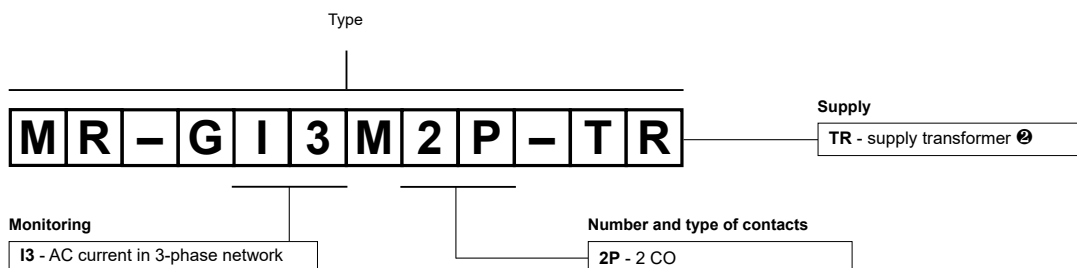

Example of ordering code:

**MR-GI3M2P-TR2** monitoring relay **MR-GI3M2P-TR2**, multifunction (relay perform 6 functions), industrial cover, width 22,5 mm, two changeover contacts, rated input voltage (supply): AC - 12 ... 400 V AC ⊗

# TR2

## supply transformers for relays MR-G... series



- Separating TR2... supply transformers for the monitoring relays of MR-G... series to reduce the input voltage applied to the terminals A1 and A2 of monitoring relays to the level required by the internal system
- TR2 transformers shall be ordered as a separate product.

### Input circuit

Supply voltage	50/60 Hz AC	12 ... 400 V
Operating range of supply voltage		0,85...1,1 U <sub>n</sub>
Rated power consumption	AC	0,5...2,0 VA
Rated frequency	AC	50/60 Hz
Duty cycle		100%
<b>General data</b>		
Dimensions (L x W x H)		32 x 35 x 16 mm
Weight		40 g
Ambient temperature	• storage • operating	-25...+70 °C -25...+55 °C
Cover protection category		IP 20
Relative humidity		15...85%

### Dimensions

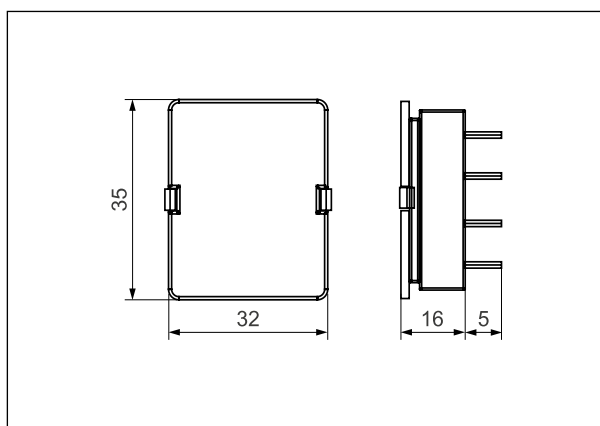

### Mounting, mechanical design

TR2 supply transformers are designed for mounting in MR-G... monitoring relays and they are inseparable for their operation. MR-G... relays will not operate without the TR2... transformers. In order to mount the TR2... transformer in the monitoring relay, it is necessary to remove the protective cap ❶ from the relay, which protects the terminals of TR2... Then, TR2... shall be placed in the assembly opening of the MR-G... relay. The cover of TR2... is made of self-extinguishing plastic. When mounted, the tightness of TR2... is IP 20.

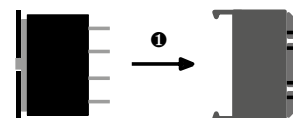

### Ordering codes

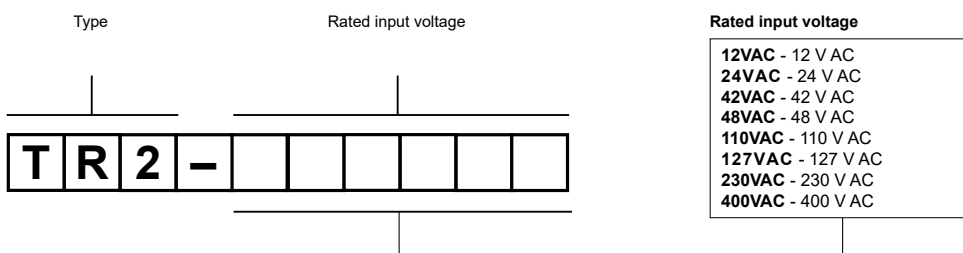

Example of ordering code:

**TR2-230VAC** supply transformer **TR2**, rated input voltage 230 V AC 50/60 Hz

### PRECAUTIONS:

1. Ensure that the parameters of the product described in its specification provide a safety margin for the appropriate operation of the device or system and never use the product in circumstances which exceed the parameters of the product. 2. Never touch any live parts of the device. 3. Ensure that the product has been connected correctly. An incorrect connection may cause malfunction, excessive heating or risk of fire. 4. In case of any risk of any serious material loss or death or injuries of humans or animals, the devices or systems shall be designed so to equip them with double safety system to guarantee their reliable operation.