

MR-GU3M2P-TR2

monitoring relays



- **Multifunctions monitoring relays (AC voltage monitoring in 3-phase network, with adjustable thresholds)** • Monitoring of phase sequence and phase failure • Asymmetry monitoring (adjustable)
- Connection of neutral wire (optional) ❶ • Timing adjustment of tripping delay • Supply via TR2 supply transformer ❷ • Output: 2 CO (2 change-over contacts) • Industrial cover, width 22,5 mm
- Direct mounting on 35 mm rail mount acc. to EN 60715
- Recognitions, certifications, directives: RoHS, CE

Output circuit - contact data

Number and type of contacts	2 CO	
Rated voltage	250 V AC	
Max. breaking capacity	AC1	750 VA (3 A / 250 V AC) ❸ 1 250 VA (5 A / 250 V AC) ❹
Max. operating frequency	3 600 cycles/hour	
• at resistive load 100 VA	360 cycles/hour	
• at resistive load 1 000 VA		
Input circuit		
Supply voltage	AC	12, 24, 42, 48, 110, 127, 230, 400 V ❷ terminals A1-A2
Must release voltage	AC: $\geq 0,3 U_n$	
Operating range of supply voltage	as per the specification of TR2 supply transformer ❷	
Rated power consumption	AC	2,0 VA / 1,5 W
Range of supply frequency	AC	as per the specification of TR2 supply transformer ❷
Duty cycle	100%	
Measuring circuit	<ul style="list-style-type: none"> • measured value • measuring inputs • overload capacity • input resistance • switching thresholds • asymmetry 	AC sinus, 48...63 Hz AC: 3(N)~ 400/230 V terminals (N)-L1-L2-L3 3(N)~ 600/346 V 3(N)~ 400/230 V: 1 M Ω MIN: 0,7...1,2 U_n MAX: 0,8...1,3 U_n adjustable: 5...25%
Insulation according to EN 60664-1		
Rated surge voltage	4 000 V 1,2 / 50 μ s	
Overtoltage category	III	
Insulation pollution degree	3	
General data		
Electrical life	• resistive AC1	$> 2 \times 10^5$ 1 000 VA
Mechanical life (cycles)	$> 2 \times 10^7$	
Dimensions (L x W x H)	90 x 22,5 x 108 mm	
Weight	100 g	
Ambient temperature	<ul style="list-style-type: none"> • storage • operating 	-25...+70 °C -25...+55 °C
(non-condensation and/or icing)		
Cover protection category	IP 20 EN 60529	
Relative humidity	15...85%	
Shock resistance	15 g 11 ms	
Vibration resistance	0,35 mm DA 10...55 Hz	
Measuring circuit data		
Functions	UNDER, UNDER+SEQ, WIN, WIN+SEQ SEQ - monitoring of phase sequence and phase failure ASYM - monitoring of asymmetry (adjustable) connection of neutral wire (optional) ❶	
Range of delay timing adjustment	tripping delay: 0,1...10 s	
Base accuracy	$\pm 5\%$ (calculated from the final range values)	
Setting accuracy	$\pm 5\%$ (calculated from the final range values)	
Repeatability	$\pm 2\%$	
Voltage influence	$\pm 0,5\%$	
Temperature influence	$\pm 0,1\%$ / °C	
Recovery time	500 ms	
LED indicator	red LED ASYM ON/OFF - indication of asymmetry ❺ red LEDs MIN and MAX ON/OFF - indication of failure ❻ red LEDs MIN and MAX flashing - indication of tripping delay ❼ red LED SEQ ON/OFF - indication of phase sequence ❸ yellow LED R ON/OFF - output relay status	

- ❶ Detection of neutral wire loss. ❷ Supply voltage depending on the TR2 transformer which shall be ordered as a separate product - see page 4.
 ❸ If the distance between the relays mounted side by side is less than 5 mm. ❹ If the distance between the relays mounted side by side is greater than 5 mm. ❺ Indication of relay status - according to the set threshold.

MR-GU3M2P-TR2

monitoring relays

Functions

For all functions the LED's MIN and MAX are flashing alternating, when the minimum value for the measured voltage was chosen to be greater than the maximum value. If a failure already exists, when the device is activated, the output relay R remains in off-position and the LED for the corresponding threshold is illuminated.

UNDER, UNDER+SEQ - Undervoltage monitoring, undervoltage monitoring with monitoring of phase sequence.

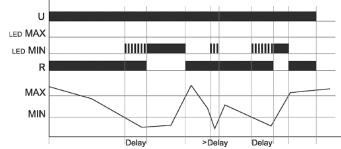

When the measured voltage (mean value of phase-to-phase voltages) falls below the value adjusted at the MIN-regulator, the set interval of the tripping delay begins (red LED MIN flashes). After the interval has expired (red LED MIN illuminated), the output relay R switches into off-position (yellow LED not illuminated). The output relay R again switches into on-position (yellow LED illuminated), when the measured voltage exceeds the value adjusted at the MAX-regulator.

WIN, WIN+SEQ - Voltage monitoring in windowfunction between MIN and MAX values, voltage monitoring in windowfunction between MIN and MAX values with monitoring of phase sequence.

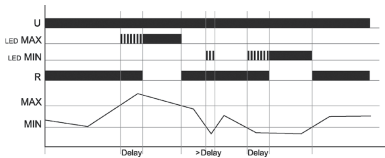

The output relay R switches into on-position (yellow LED illuminated) when the measured voltage (mean value of phase-to-phase voltages) exceeds the value adjusted at the MIN-regulator. When the measured voltage exceeds the value adjusted at the MAX-regulator, the set interval of the tripping delay begins (red LED MAX flashes). After the interval has expired (red LED MAX illuminated), the output relay R switches into off-position (yellow LED not illuminated). The output relay R again switches into on-position (yellow LED illuminated) when the measured voltage falls below the value adjusted at the MAX-regulator (red LED MAX not illuminated). When the measured voltage falls below the value adjusted at the MIN-regulator, the set interval of the tripping delay begins again (red LED MIN flashes). After the interval has expired (red LED MIN illuminated), the output relay R switches into off-position (yellow LED not illuminated).

SEQ - Phase sequence monitoring.

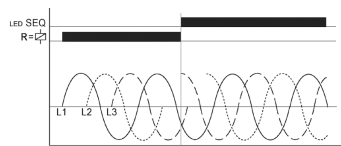

Phase sequence monitoring is selectable for all functions. If a change in phase sequence is detected (red LED SEQ illuminated), the output relay R switches into off-position immediately (yellow LED not illuminated).

SEQ - Phase failure monitoring.

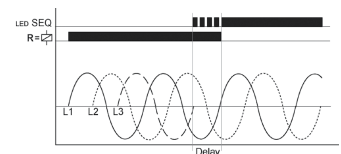

If one of the phase voltages fails, the set interval of the tripping delay begins (red LED SEQ flashes). After the interval has expired (red LED SEQ illuminated), the output relay R switches into off-position (yellow LED not illuminated). Reverse voltages of a consumer (e.g. a motor which continues to run on two phases only) do not effect the disconnection but can be monitored by using a proper value for the asymmetry.

ASYM - Asymmetry monitoring.

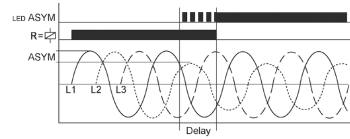

If the asymmetry of the phase-to-phase voltages exceeds the value set at the ASYM-regulator, the set interval of the tripping delay begins (red LED ASYM flashes). After the interval has expired (red LED ASYM illuminated), the output relay R switches into off-position (yellow LED not illuminated). If the neutral wire is connected to the device, the asymmetry of the phase voltages referred to the neutral wire (Y-voltage) is monitored also. In that case both values of the asymmetry are evaluated and if one of the values exceeds the value set at the ASYM-regulator, the set interval of the tripping delay begins (red LED ASYM flashes). After the interval has expired (red LED ASYM illuminated), the output relay R switches into off-position (yellow LED not illuminated).

Loss of neutral wire by means of evaluation of asymmetry.

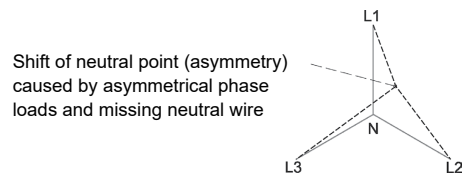

A break of the neutral wire between power line and machinery is detected as soon as asymmetry between phase-to-phase voltage and neutral wire occurs. If the asymmetry exceeds the value set at the ASYM-regulator, the set interval of the tripping delay begins (red LED ASYM flashes). After the interval has expired (red LED ASYM illuminated), the output relay R switches into off-position (yellow LED not illuminated). A break of the neutral wire between our device and the machinery can not be detected.

U - supply voltage; **R** - output state of the relay; **MIN, MAX** - relay status; **SEQ** - phase sequence; **ASYM** - asymmetry; **Delay** - delay time

Front panel description

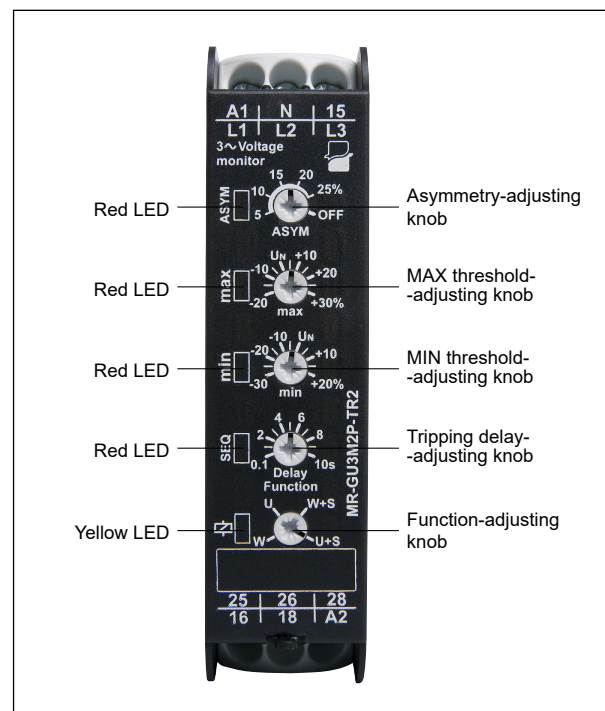

MR-GU3M2P-TR2

monitoring relays

Dimensions

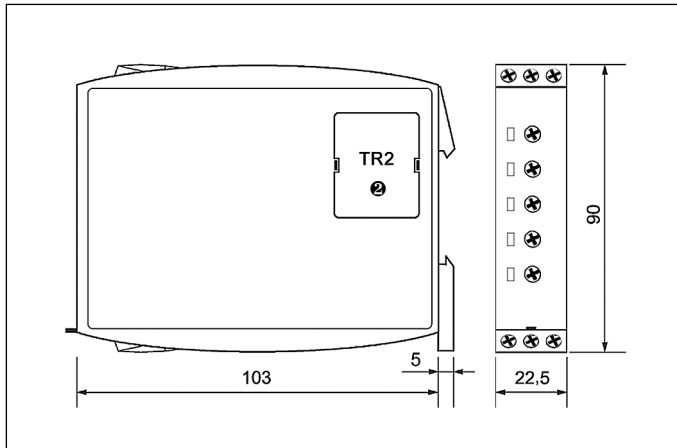

Mounting

Relays **MR-GU3M2P-TR2** are designed for direct mounting on 35 mm rail mount acc. to EN 60715. Operational position - any. **Terminals - cross section of the connection cables:** 1 x 0,5 ... 2,5 mm² with/without multicore cable end, 1 x 4 mm² without multicore cable end, 2 x 0,5 ... 1,5 mm² with/without multicore cable end, 2 x 2,5 mm² flexible without multicore cable end.

⊗ Supply voltage depending on the TR2 transformer which shall be ordered as a separate product - see page 4.

Connection diagrams

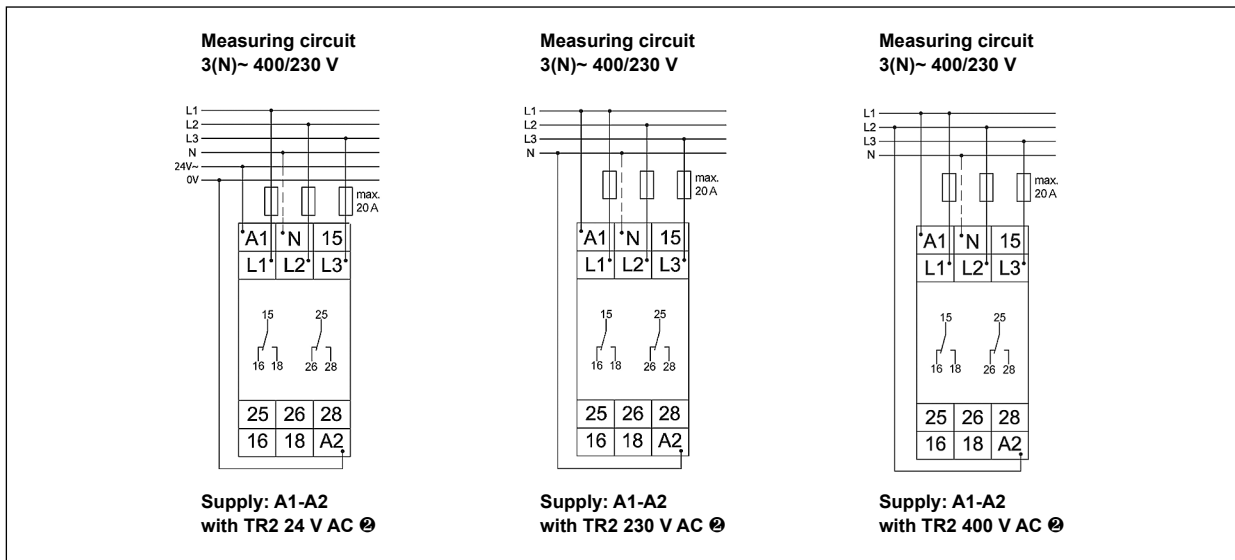

Ordering codes

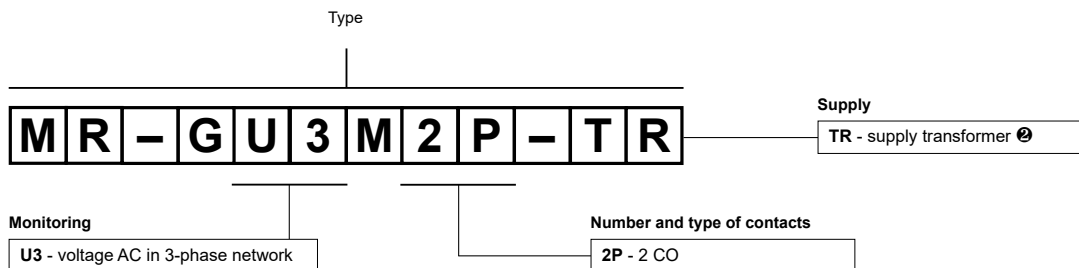

Example of ordering code:

MR-GU3M2P-TR2 monitoring relay **MR-GU3M2P-TR2**, multifunction (relay perform 6 functions), industrial cover, width 22,5 mm, two changeover contacts, rated input voltage (supply): AC - 12, 24, 42, 48, 110, 127, 230, 400 V AC ⊗

TR2

supply transformers for relays MR-G... series



- Separating TR2... supply transformers for the monitoring relays of MR-G... series to reduce the input voltage applied to the terminals A1 and A2 of monitoring relays to the level required by the internal system
- TR2 transformers shall be ordered as a separate product.

Input circuit

Supply voltage	50/60 Hz AC	12, 24, 42, 48, 110, 127, 230, 400 V
Operating range of supply voltage		0,85...1,1 U _n
Rated power consumption	AC	0,5...2,0 VA
Rated frequency	AC	50/60 Hz
Duty cycle		100%
General data		
Dimensions (L x W x H)		32 x 35 x 16 mm
Weight		40 g
Ambient temperature (non-condensation and/or icing)	• storage • operating	-25...+70 °C -25...+55 °C
Cover protection category		IP 20
Relative humidity		15...85%

Dimensions

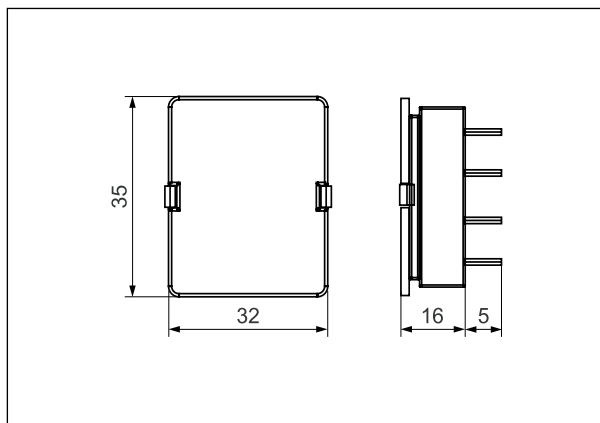

Mounting, mechanical design

TR2 supply transformers are designed for mounting in MR-G... monitoring relays and they are inseparable for their operation. MR-G... relays will not operate without the TR2... transformers. In order to mount the TR2... transformer in the monitoring relay, it is necessary to remove the protective cap ❶ from the relay, which protects the terminals of TR2... Then, TR2... shall be placed in the assembly opening of the MR-G... relay. The cover of TR2... is made of self-extinguishing plastic. When mounted, the tightness of TR2... is IP 20.

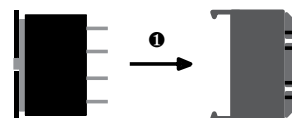

Ordering codes

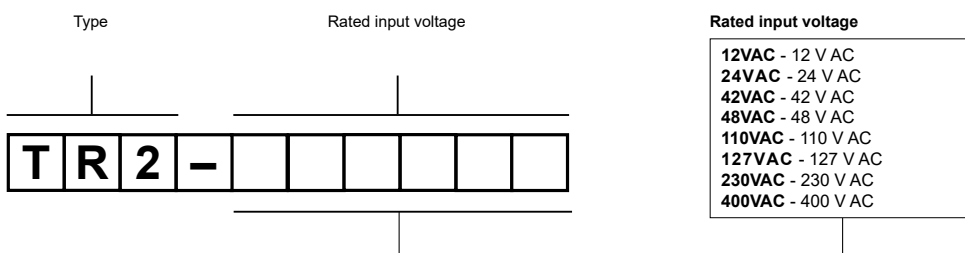

Example of ordering code:

TR2-230VAC supply transformer **TR2**, rated input voltage 230 V AC 50/60 Hz

PRECAUTIONS:

1. Ensure that the parameters of the product described in its specification provide a safety margin for the appropriate operation of the device or system and never use the product in circumstances which exceed the parameters of the product. 2. Never touch any live parts of the device. 3. Ensure that the product has been connected correctly. An incorrect connection may cause malfunction, excessive heating or risk of fire. 4. In case of any risk of any serious material loss or death or injuries of humans or animals, the devices or systems shall be designed so to equip them with double safety system to guarantee their reliable operation.