



- **Multifunction time relays (7 time functions; 8 time ranges)**
- Cadmium - free contacts • AC/DC input voltages
- Cover - modular, width 17,5 mm
- Direct mounting on 35 mm rail mount acc. to PN-EN 60715
- Applications: in low-voltage systems
- Compliance with standard PN-EN 61812-1
- Recognitions, certifications, directives: **CE ENEC**

Output circuit - contact data

Number and type of contacts	1 CO	
Contact material	AgSnO ₂	
Max. switching voltage	400 V AC / 300 V DC	
Rated load	AC1	10 A / 250 V AC
	DC1	10 A / 24 V DC; 0,3 A / 250 V DC
Rated current	10 A / 250 V AC	
Max. breaking capacity	AC1	16 A / 250 V AC
Min. breaking capacity	1 W 10 V, 10 mA	
Contact resistance	≤ 100 mΩ	
Max. operating frequency		
• at rated load	AC1	600 cycles/hour
Input circuit		
Rated voltage	AC: 50/60 Hz AC/DC	12...240 V terminals (+)A1 – (-)A2
Operating range of supply voltage	0,9...1,1 U _n	
Rated power consumption	AC	≤ 4,5 VA AC: 50 Hz
	DC	≤ 1,5 W
Range of supply frequency	AC	48...63 Hz
Control contact S ①		
• min. voltage ②	0,7 U _n	
• min. time of pulse duration ②	AC: ≥ 50 ms	DC: ≥ 20 ms
Insulation according to PN-EN 60664-1		
Insulation rated voltage	250 V AC	
Rated surge voltage	2 500 V 1,2 / 50 μs	
Overvoltage category	II	
Insulation pollution degree	1	
Flammability class	V-0 UL94	
Dielectric strength	• input - output	2 500 V AC type of insulation: basic
	• contact clearance	1 000 V AC type of clearance: micro-disconnection
General data		
Electrical life	• resistive AC1	> 0,5 x 10 ⁵ 10 A, 250 V AC
Mechanical life (cycles)	> 3 x 10 ⁷	
Dimensions (L x W x H) / Weight	90 ③ x 17,5 x 63,5 mm / 64 g	
Ambient temperature	• storage	-40...+70 °C
	• operating	-20...+45 °C
Cover protection category	IP 20	PN-EN 60529
Relative humidity	up to 85%	
Shock / vibration resistance	15 g / 0,35 mm 10...55 Hz	
Time module data		
Functions	E, Wu, Bp, T, R, Ws, Wa permanent switching ON and OFF	
Time ranges	1 s ④; 10 s; 1 min.; 10 min.; 1 h; 10 h; 1 d; 10 d	
Timing adjustment	smooth - (0,1...1) x time range	
Setting accuracy	± 5% ⑤ ⑥	
Repeatability	± 0,5% ⑥	
Values affecting the timing adjustment	• temperature	± 0,05% / °C
	• humidity	± 0,05% / %HR
Recovery time	≤ 50 ms	
LED indicator	green LED U ON - indication of supply voltage U green LED U flashing - measurement of T time yellow LED R ON/OFF - output relay status	

① The control terminal S is activated by connection to A1 terminal via the external control contact S. ② Where the control signal is recognizable.
③ Length with 35 mm rail taps: 98,8 mm. ④ For first range setpoint (1 s) setting accuracy and repeatability are smaller than the given ones in technical parameters (significant influence of the operational relay operating time, processor start-time, and the moment of supply switching as referred to the AC supply course). ⑤ Calculated from the final range values, for the setting direction from minimum to maximum.

Time functions

Permanent switching ON and OFF.

The functions ON and OFF are selected with TIME potentiometer. In the ON function, the normally open contacts are closed all the time whereas in the OFF function they are open. The position of the FUNC potentiometer is of no significance in these functions as is the preset measurement time. The ON or OFF functions are used for the time relay operation control in electric systems.

E - ON delay.

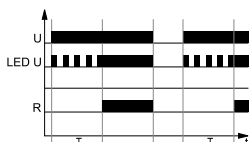

On applying the supply voltage U the set interval T begins - off-delay of the output relay R. After the interval T has lapsed, the output relay R switches on and remains on until supply voltage U is interrupted.

Wu - ON for the set interval.

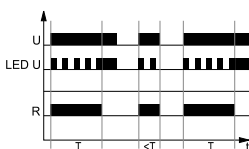

Applying the supply voltage U immediately switches the output relay R on for the set interval T. After the interval T has lapsed, the output relay R switches off.

Bp - Symmetrical cyclical operation pause first.

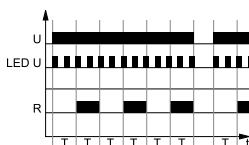

Applying the supply voltage U starts the cyclical operation from the T interval - switching the output relay R off followed by switching on the output relay R for the interval T. The cyclical operation lasts until the supply voltage U is interrupted.

T - Generation of the 0,5 s pulse after the interval T.

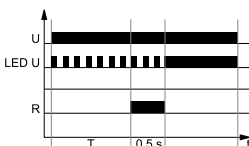

Applying the supply voltage U starts the interval T. After the interval T has lapsed, the output relay switches on for 0,5 s (the time of the NO contact of the output relay).

R - OFF delay with the control contact S.

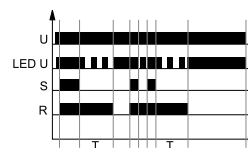

The input of the time relay is supplied with voltage U continuously. Closing of the control contact S immediately switches on the output relay R. Opening of the control contact S starts the set time of the delayed switching off of the output relay R. After the interval T has lapsed, the output relay R switches off. If the control contact S is closed during the interval T, the already measured time is reset, and the output relay R is switched on again. The OFF delay of the output relay R will start when the control contact S is opened again.

Ws - Single shot for the set interval triggered by closing of the control contact S.

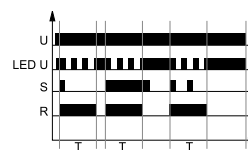

The input of the time relay is supplied with voltage U continuously. Closing of the control contact S immediately switches the output relay R on for the set interval T. After the interval T has lapsed, the output relay R is switched off. In the course of the interval T, any opening of the control contact S does not affect the function to be performed. The output relay R may be switched on again for the set interval, after the interval T has lapsed, by closing the control contact S again.

Wa - ON for the set interval triggered with the control contact S.

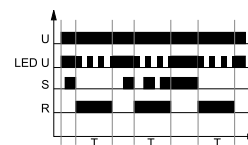

The input of the time relay is supplied with voltage U continuously. Closing of the control contact S does not start the interval T, and it does not change the position of the output relay R. Opening of the control contact S immediately switches on the output relay R for the set time. After the interval T has lapsed, the output relay R switches off. Opening and closing of the control contact S in the course of the interval T does not affect the function to be performed. The output relay R may be switched on again for the set interval with another closing and opening of the control contact S.

U - supply voltage; R - output state of the relay; S - control contact state; T - measured time; t - time axis

Additional functions

Supply diode: it is lit permanently when the time is not being measured. In course of the T time measurement, it flashes at 500 ms period where it is lit for 80% of the time, and off for 20% of the time.

Adjustment of the set values:

- the values of time and range are read in the course of the relay's operation. The set values may be modified at any moment,
- no change of the function is possible in the course of the relay's operation. Any change of the settings of the relay shall be read only after the supply voltage has been switched off and on again.

Release: depending on the function to be performed, the relay is released with the supply voltage or by connection of the S contact to the A1 line. For DC supply, the positive pole must be connected to the A1 line. The level of the S contact activation is adjusted automatically depending on the supply voltage.

Supply: the relay may be supplied with DC voltage or AC voltage 48...63 Hz of 10,8...250 V. A programmed control of the supply voltage has been applied so the processor shall not start operation if the voltage is lower than approximately 10 V. The supply voltage is permanently monitored in course of the operation of the relay. When the voltage drops below 9 V for more than 50 ms, the relay shall be reset. Owing to this, the regeneration time is programmed to 50 ms, and it does not depend on the tolerance of the elements.

MT-TUA-...

time relays

Dimensions

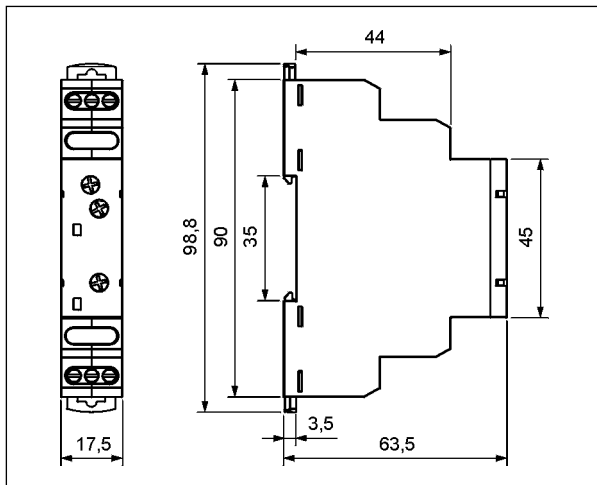

Front panel description

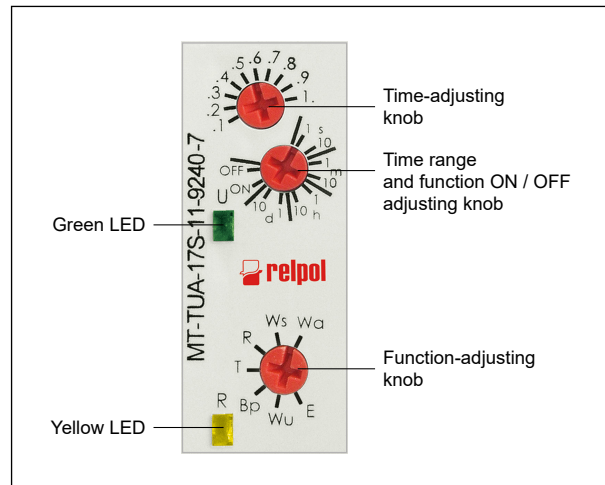

Connection diagram

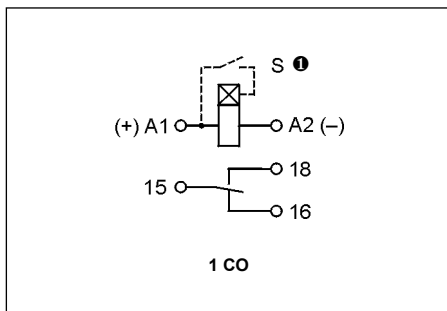

❶ The control terminal S is activated by connection to A1 terminal via the external control contact S.

Mounting

Relays **MT-TUA-...** are designed for direct mounting on 35 mm rail mount acc. to PN-EN 60715. Operational position - any. **Connections:** max. cross section of the cables: 1 x 2,5 mm² / 2 x 1,5 mm² (1 x 14 / 2 x 16 AWG), length of the cable deinsulation: 6,5 mm, max. tightening moment for the terminal: 0,6 Nm.



Two taps:
easy assembly on 35 mm rail,
firm tapping (top and bottom).

Ordering codes

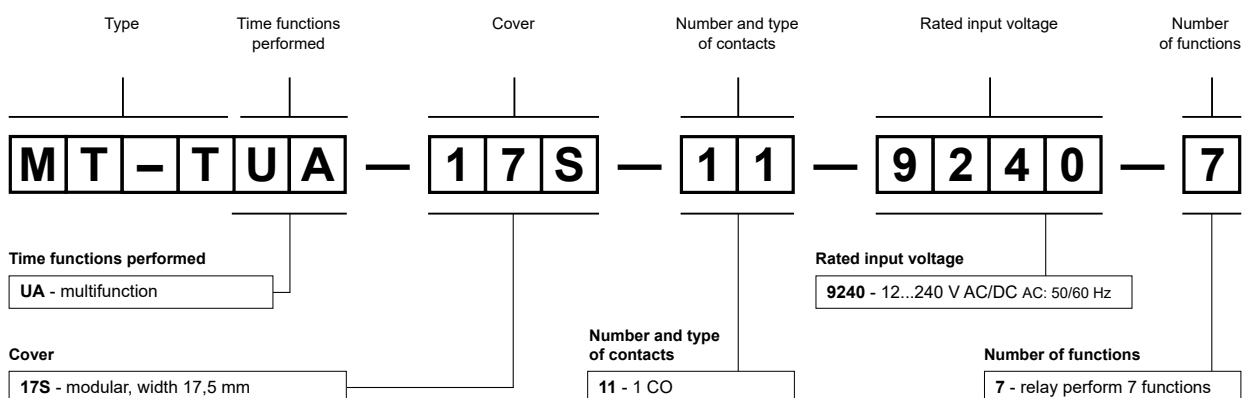

Example of ordering code:

MT-TUA-17S-11-9240-7 time relay **MT-TUA-...**, multifunction (relay perform 7 functions), cover - modular, width 17,5 mm, one changeover contact, contact material AgSnO₂, rated input voltage 12...240 V AC/DC AC: 50/60 Hz

PRECAUTIONS:

1. Ensure that the parameters of the product described in its specification provide a safety margin for the appropriate operation of the device or system and never use the product in circumstances which exceed the parameters of the product. 2. Never touch any live parts of the device. 3. Ensure that the product has been connected correctly. An incorrect connection may cause malfunction, excessive heating or risk of fire. 4. In case of any risk of any serious material loss or death or injuries of humans or animals, the devices or systems shall be designed so to equip them with double safety system to guarantee their reliable operation.