

RPC-2ME-UNI-SSR

time relays

Time module data

Functions	E, Wu, Bp, Bi, R, Ws, Wa, Esa, B, T
Operation mode adjustments	ONE, BOTH
Time ranges	OFF - permanent switching off; ON - permanent switching on 1 s ④; 10 s; 1 min.; 10 min.; 1 h; 10 h; 1 d; 10 d
Timing adjustment	smooth - (0,1...1) x time range (does not refer to range ON / OFF)
Setting accuracy / Repeatability	± 5% ⑤ ④ / ± 0,5% ④
Values affecting the timing adjustment	temperature: ± 0,05% / °C supply voltage: ± 0,01% / V
Recovery time	AC: ≤ 600 ms DC: ≤ 150 ms
LED indicator	green LED U ON - indication of supply voltage U green LED U flashing - measurement of T time yellow LEDs R1, R2 ON/OFF - output relays status

④ For first range setpoint (1 s) setting accuracy and repeatability are smaller than the given ones in technical parameters (significant influence of the operational relay operating time, processor start-time, and the moment of supply switching as referred to the AC supply course). ⑤ Calculated from the final range values, for the setting direction from minimum to maximum.

Dimensions

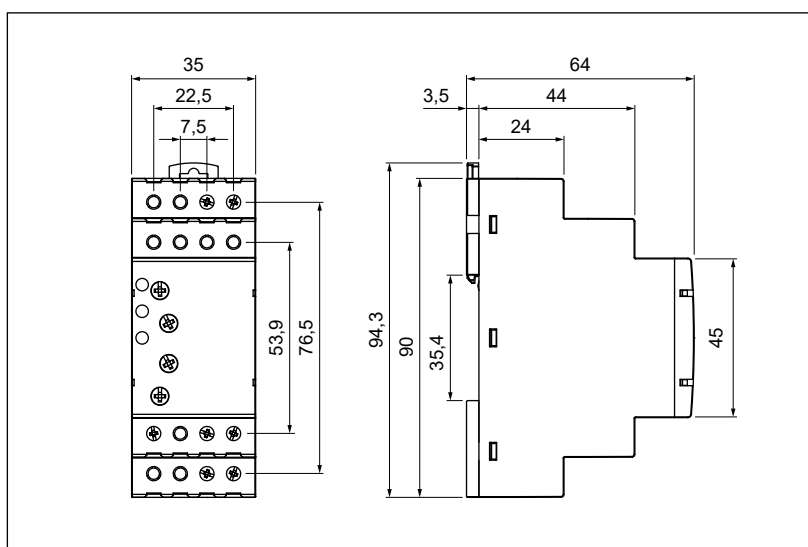

Connection diagram

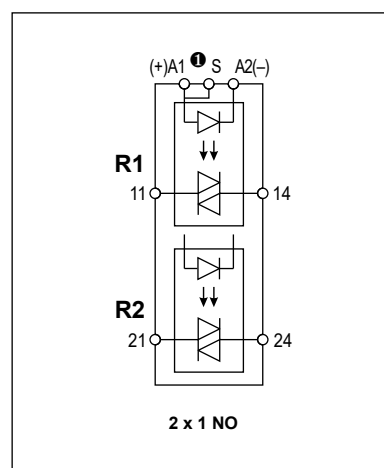

① The control terminal S is activated by connection to A1 terminal via the external control contact S.

Front panel description

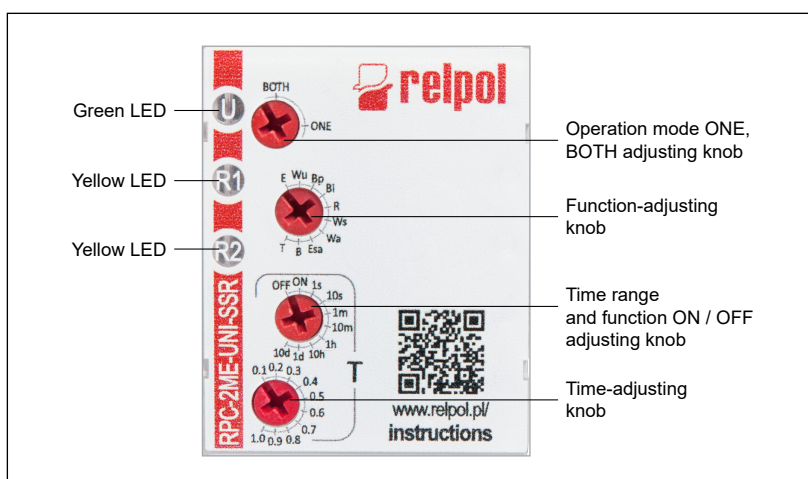

Time functions

Operation mode ONE: when the supply voltage is applied, the instantaneous relay R1 switches to the ON position. Time-delayed relay R2 operates with selected time function.

Operation mode BOTH: both time-delayed relays R1 and R2 operate with selected time function.

E - ON delay (operation mode ONE).

E - ON delay (operation mode BOTH).

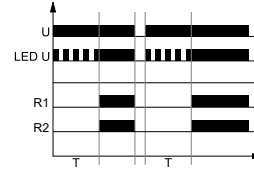
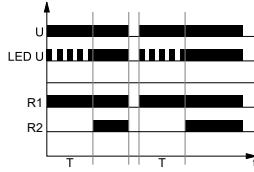

On applying the supply voltage U the set interval T begins - off-delay of the output relay R2. After the interval T has lapsed, the output relay R2 switches on and remains on until supply voltage U is interrupted.

On applying the supply voltage U the set interval T begins - off-delay of the output relays R1 and R2. After the interval T has lapsed, the output relays R1 and R2 switches on and remains on until supply voltage U is interrupted.

Wu - ON for the set interval (operation mode ONE).

Wu - ON for the set interval (operation mode BOTH).

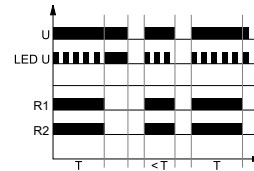
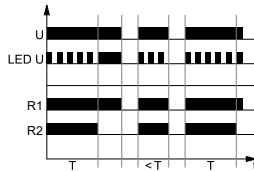

Applying the supply voltage U immediately switches the output relay R2 on for the set interval T. After the interval T has lapsed, the output relay R2 switches off.

Applying the supply voltage U immediately switches the output relays R1 and R2 on for the set interval T. After the interval T has lapsed, the output relays R1 and R2 switches off.

Bp - Symmetrical cyclical operation pause first (operation mode ONE).

Bp - Symmetrical cyclical operation pause first (operation mode BOTH).

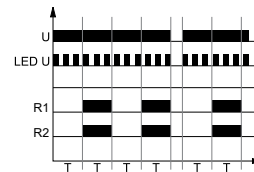
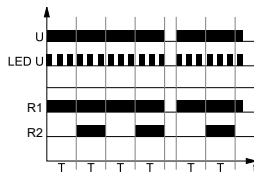

Applying the supply voltage U starts the cyclical operation from the interval T - switching the output relay R2 off followed by switching on the output relay R2 for the interval T. The cyclical operation lasts until the supply voltage U is interrupted.

Applying the supply voltage U starts the cyclical operation from the interval T - switching the output relays R1 and R2 off followed by switching on the output relays R1 and R2 for the interval T. The cyclical operation lasts until the supply voltage U is interrupted.

Bi - Symmetrical cyclical operation pulse first (operation mode ONE).

Bi - Symmetrical cyclical operation pulse first (operation mode BOTH).

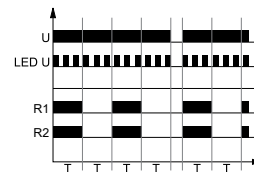
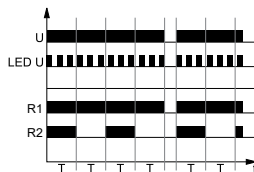

Applying the supply voltage U starts the cyclical operation from switching on the output relay R2 for the set interval T. After the interval T has lapsed, the output relay R2 switches off for the interval T. The cyclical operation lasts until the supply voltage U is interrupted.

Applying the supply voltage U starts the cyclical operation from switching on the output relays R1 and R2 for the set interval T. After the interval T has lapsed, the output relays R1 and R2 switches off for the interval T. The cyclical operation lasts until the supply voltage U is interrupted.

R - OFF delay with the control contact S (operation mode ONE).

R - OFF delay with the control contact S (operation mode BOTH).

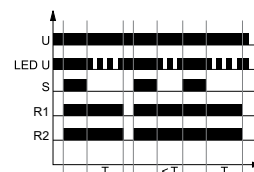
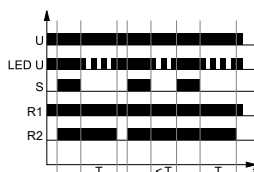

The input of the time relay is supplied with voltage U continuously. Closing of the control contact S immediately switches on the output relay

The input of the time relay is supplied with voltage U continuously. Closing of the control contact S immediately switches on the output relays

U - supply voltage; R1, R2 - output states of the relays; S - control contact state; T - measured time; t - time axis

Time functions

R2. Opening of the control contact S starts the set time of the delayed switching off of the output relay R2. After the interval T has lapsed, the output relay R2 switches off. If the control contact S is closed during the interval T, the already measured time is reset, and the output relay R2 is switched on again. The OFF delay of the output relay R2 will start when the control contact S is opened again.

Ws - Single shot for the set interval triggered by closing of the control contact S (operation mode ONE).

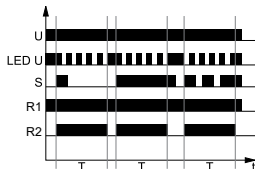

The input of the time relay is supplied with voltage U continuously. Closing of the control contact S immediately switches the output relay R2 on for the set interval T. After the interval T has lapsed, the output relay R2 is switched off. In the course of the interval T, any opening of the control contact S does not affect the function to be performed. The output relay R2 may be switched on again for the set interval, after the interval T has lapsed, by closing the control contact S again.

Wa - ON for the set interval triggered with the control contact S (operation mode ONE).

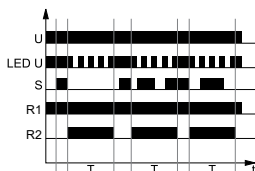

The input of the time relay is supplied with voltage U continuously. Closing of the control contact S does not start the interval T, and it does not change the position of the output relay R2. Opening of the control contact S immediately switches on the output relay R2 for the set time. After the interval T has lapsed, the output relay R2 switches off. Opening and closing of the control contact S in the course of the interval T does not affect the function to be performed. The output relay R2 may be switched on again for the set interval with another closing and opening of the control contact S.

Esa - ON and OFF delay with the control contact S (operation mode ONE).

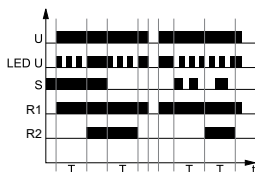

The input of the time relay is supplied with voltage U continuously. Closing of the control contact S starts the interval T - on-delay of the output relay R2. After the interval T has lapsed, the output relay R2 switches on. Opening of the control contact S begins further measurement of the interval T - off-delay of the output relay R2, and after the interval has lapsed, the output relay switches off. In case the time for which the control contact S is closed in the course of measurement of the on-delay of the output relay R2 is shorter than the set interval T, the output relay R2 will switch on after the set interval T, and the output relay R2 will remain in on position for the interval T. When the output relay R2 is in on position, closing of the control contact S does not affect the function to be performed.

U - supply voltage; R1, R2 - output states of the relays; S - control contact state; T - measured time; t - time axis

R1 and R2. Opening of the control contact S starts the set time of the delayed switching off of the output relays R1 and R2. After the interval T has lapsed, the output relays R1 and R2 switches off. If the control contact S is closed during the interval T, the already measured time is reset, and the output relays R1 and R2 are switched on again. The OFF delay of the output relays R1 and R2 will start when the control contact S is opened again.

Ws - Single shot for the set interval triggered by closing of the control contact S (operation mode BOTH).

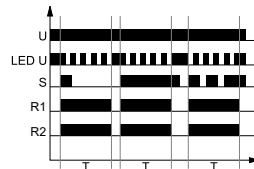

The input of the time relay is supplied with voltage U continuously. Closing of the control contact S immediately switches the output relays R1 and R2 on for the set interval T. After the interval T has lapsed, the output relays R1 and R2 are switched off. In the course of the interval T, any opening of the control contact S does not affect the function to be performed. The output relays R1 and R2 may be switched on again for the set interval, after the interval T has lapsed, by closing the control contact S again.

Wa - ON for the set interval triggered with the control contact S (operation mode BOTH).

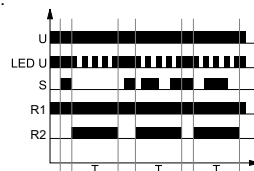

The input of the time relay is supplied with voltage U continuously. Closing of the control contact S does not start the interval T, and it does not change the position of the output relays R1 and R2. Opening of the control contact S immediately switches on the output relays R1 and R2 for the set time. After the interval T has lapsed, the output relays R1 and R2 switches off. Opening and closing of the control contact S in the course of the interval T does not affect the function to be performed. The output relays R1 and R2 may be switched on again for the set interval with another closing and opening of the control contact S.

Esa - ON and OFF delay with the control contact S (operation mode BOTH).

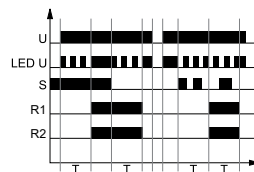

The input of the time relay is supplied with voltage U continuously. Closing of the control contact S starts the interval T - on-delay of the output relays R1 and R2. After the interval T has lapsed, the output relays R1 and R2 switches on. Opening of the control contact S begins further measurement of the interval T - off-delay of the output relays R1 and R2, and after the interval has lapsed, the output relays switches off. In case the time for which the control contact S is closed in the course of measurement of the on-delay of the output relays R1 and R2 is shorter than the set interval T, the output relays R1 and R2 will switch on after the set interval T, and the output relays R1 and R2 will remain in on position for the interval T. When the output relays R1 and R2 are in on position, closing of the control contact S does not affect the function to be performed.

Time functions

B - Cyclical operation controlled with closing of the control contact S (operation mode ONE).

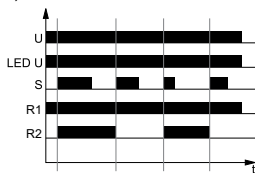

The input of the time relay is supplied with U voltage continuously. Closing of the control contact S immediately switches on the output relay R2. Each next closing of the control contact S results in a change of the status of the output relay R2 to an opposite one (the feature of a bistable relay).

B - Cyclical operation controlled with closing of the control contact S (operation mode BOTH).

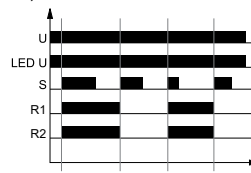

The input of the time relay is supplied with U voltage continuously. Closing of the control contact S immediately switches on the output relays R1 and R2. Each next closing of the control contact S results in a change of the status of the output relays R1 and R2 to an opposite one (the feature of a bistable relay).

T - Generation of the 0,5 s pulse after the interval T (operation mode ONE).

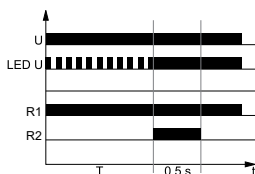

Applying the supply voltage U starts the interval T. After the interval T has lapsed, the output relay R2 switches on for 0,5 s (the time of the NO contact of the output relay R2).

T - Generation of the 0,5 s pulse after the interval T (operation mode BOTH).

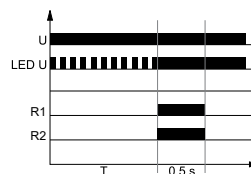

Applying the supply voltage U starts the interval T. After the interval T has lapsed, the output relays R1 and R2 switches on for 0,5 s (the time of the NO contacts of the output relays R1 and R2).

ON / OFF - Permanent switching on / off.

The functions ON and OFF are selected with T time range adjusting knob. In the ON function, the normally open contacts are closed all the time whereas in the OFF function they are open. The position of the function -adjusting knob is of no significance in these functions as is the preset measurement time. The ON or OFF functions are used for the time relay operation control in electric systems.

ON / OFF - Permanent switching on / off.

The functions ON and OFF are selected with T time range adjusting knob. In the ON function, the normally open contacts are closed all the time whereas in the OFF function they are open. The position of the function -adjusting knob is of no significance in these functions as is the preset measurement time. The ON or OFF functions are used for the time relay operation control in electric systems.

U - supply voltage; **R1, R2** - output states of the relays; **S** - control contact state; **T** - measured time; **t** - time axis

Additional functions

Supply diode: it is lit permanently when the time is not being measured. In course of the T time measurement, it flashes at 500 ms period where it is lit for 50% of the time, and off for 50% of the time.

Adjustment of the set values:

- the values of time and range are read in the course of the relay's operation. The set values may be modified at any moment, no change of the function is possible in the course of the relay's operation. Any change of the settings of the relay shall be read only after the supply voltage has been switched off and on again.
- change of function to BOTH or to ONE: turning power off and on is not required. After power on: ONE - relay R1 is permanently switched on,

while only relay R2 performs the timing function; BOTH - both relays R1 and R2 perform the timing function.

Triggering: depending on the function to be performed, the relay is triggered with the supply voltage or by connection of the S contact to the A1 line. For DC supply, the positive pole must be connected to the A1 line. The level of the S contact activation is adjusted automatically depending on the supply voltage.

Supply: the relay may be supplied with DC voltage or AC voltage 48...63 Hz of 10,8...264 V.

RPC-2ME-UNI-SSR

time relays

Mounting

Relays **RPC-2ME-UNI-SSR** are designed for direct mounting on 35 mm rail mount acc. to EN 60715 - one catch: firm hold (top). Operational position - any. **Connections:** max. cross section of the cables: 1 x 2,5 mm² (1 x 14 AWG), stripping length: 6,5 mm, max. tightening moment for the terminal: 0,5 Nm - mounting wires in clamps: universal screw (cross-recessed or slotted head).

Ordering codes

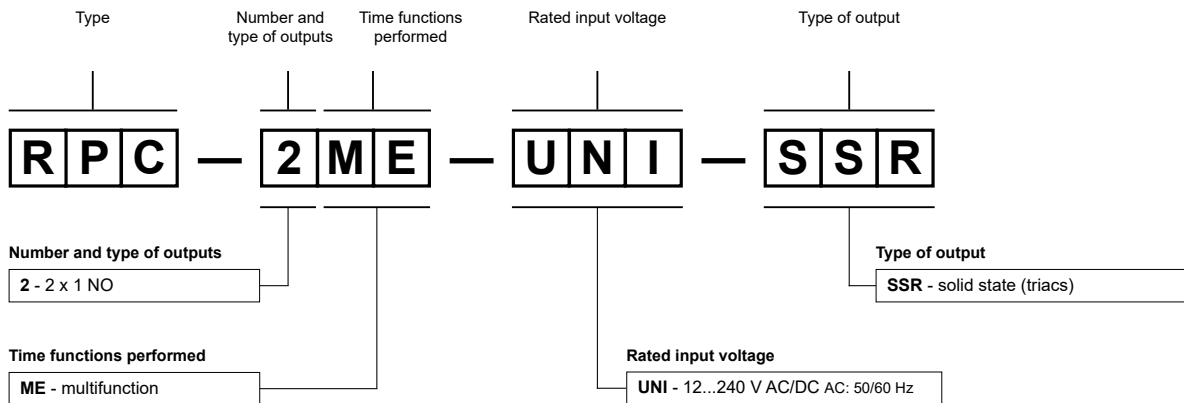

Example of ordering code:

RPC-2ME-UNI-SSR time relay **RPC-2ME-UNI-SSR**, multifunction (relay perform 10 functions), cover - modular, width 35 mm, two normally open outputs (triacs), rated input voltage 12...240 V AC/DC AC: 50/60 Hz

PRECAUTIONS:

1. Ensure that the parameters of the product described in its specification provide a safety margin for the appropriate operation of the device or system and never use the product in circumstances which exceed the parameters of the product. 2. Never touch any live parts of the device. 3. Ensure that the product has been connected correctly. An incorrect connection may cause malfunction, excessive heating or risk of fire. 4. In case of any risk of any serious material loss or death or injuries of humans or animals, the devices or systems shall be designed so to equip them with double safety system to guarantee their reliable operation.